

ESQUINERO REGULABLE

Ref.: 1622

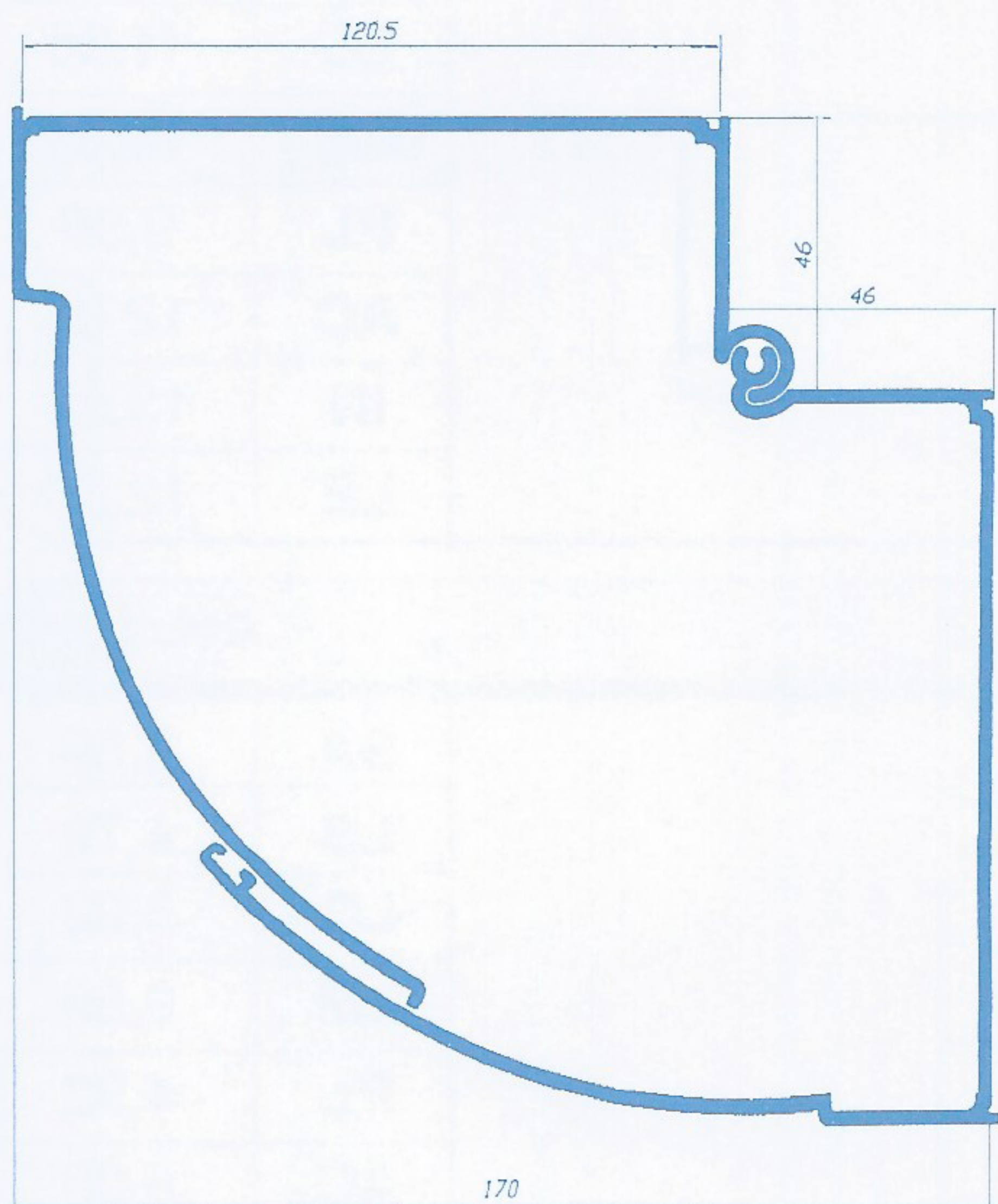

UNIÓN MAINEL MONOBLOCK

Ref.: 1667

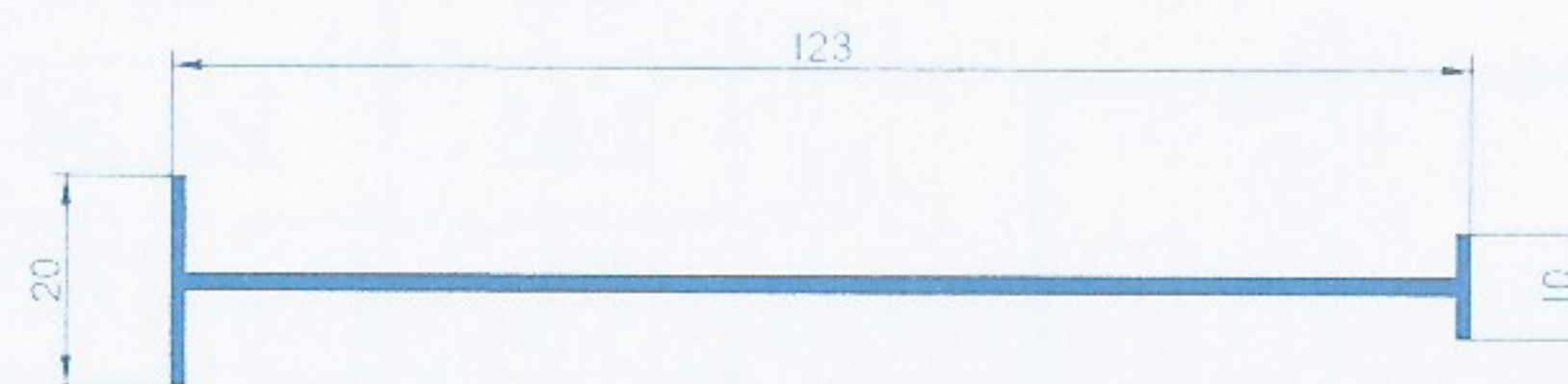

MAINEL MONOBLOCK

Ref.: 1705

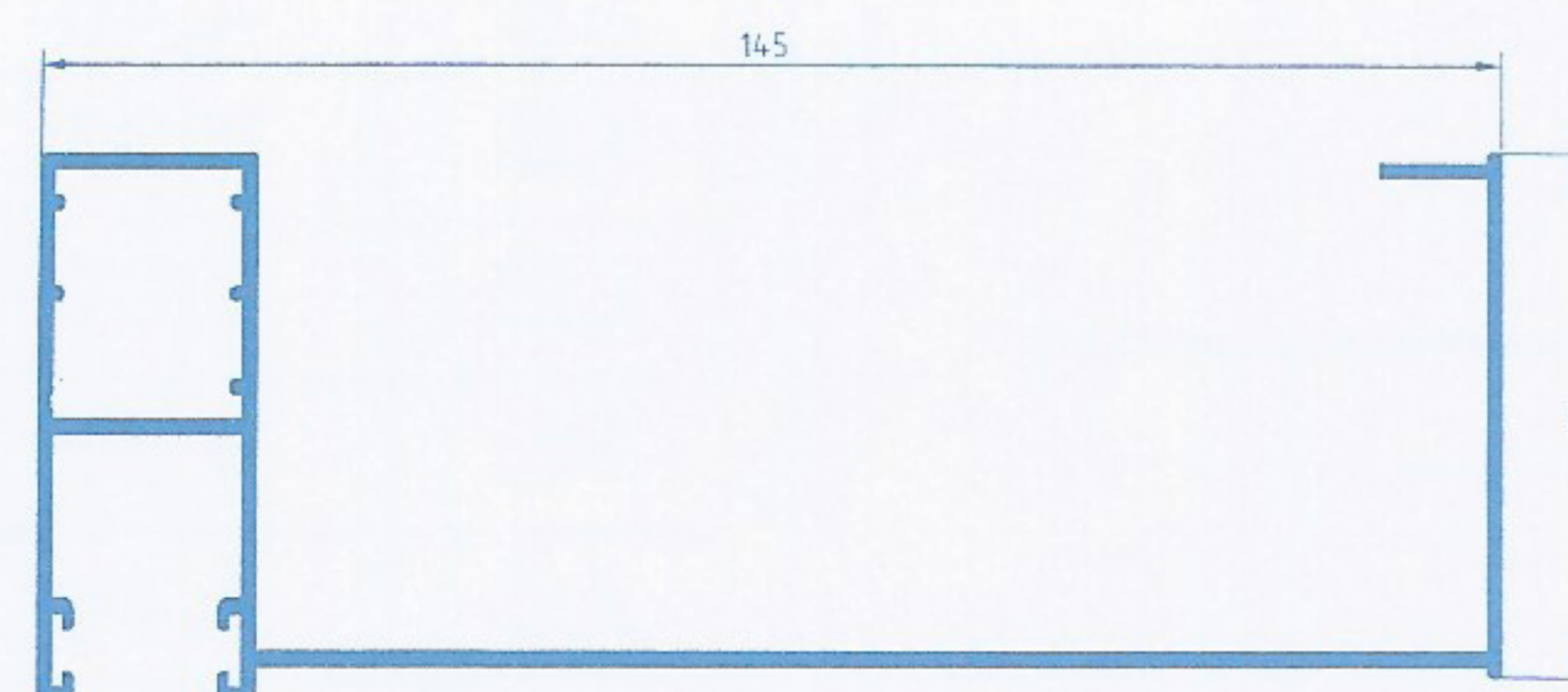

TERMINAL DE PERSIANA

Ref.: 2430

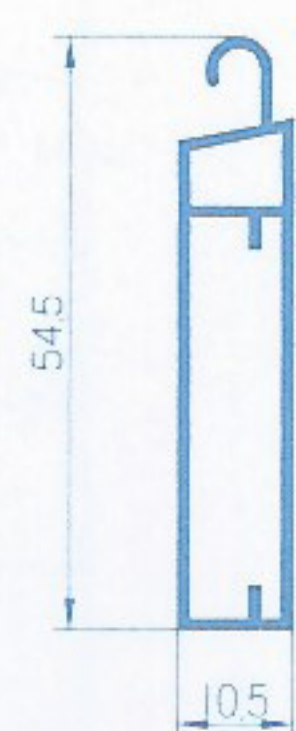

GUÍA DE PERSIANA REDUCTORA

Ref.: 2508

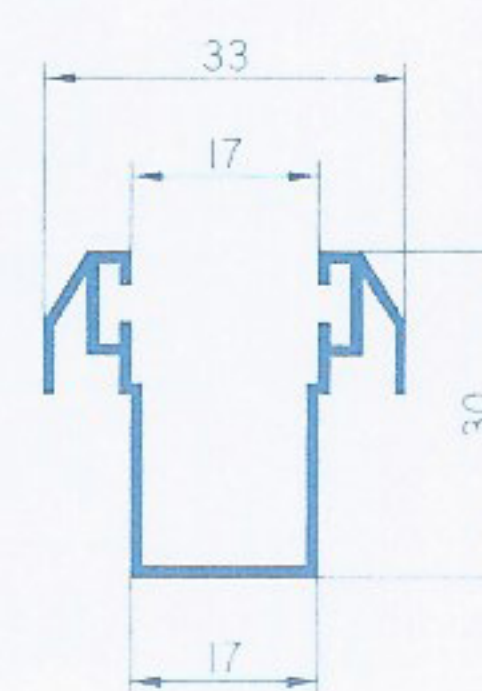

MAINEL MONOBLOCK

Ref.: 2536

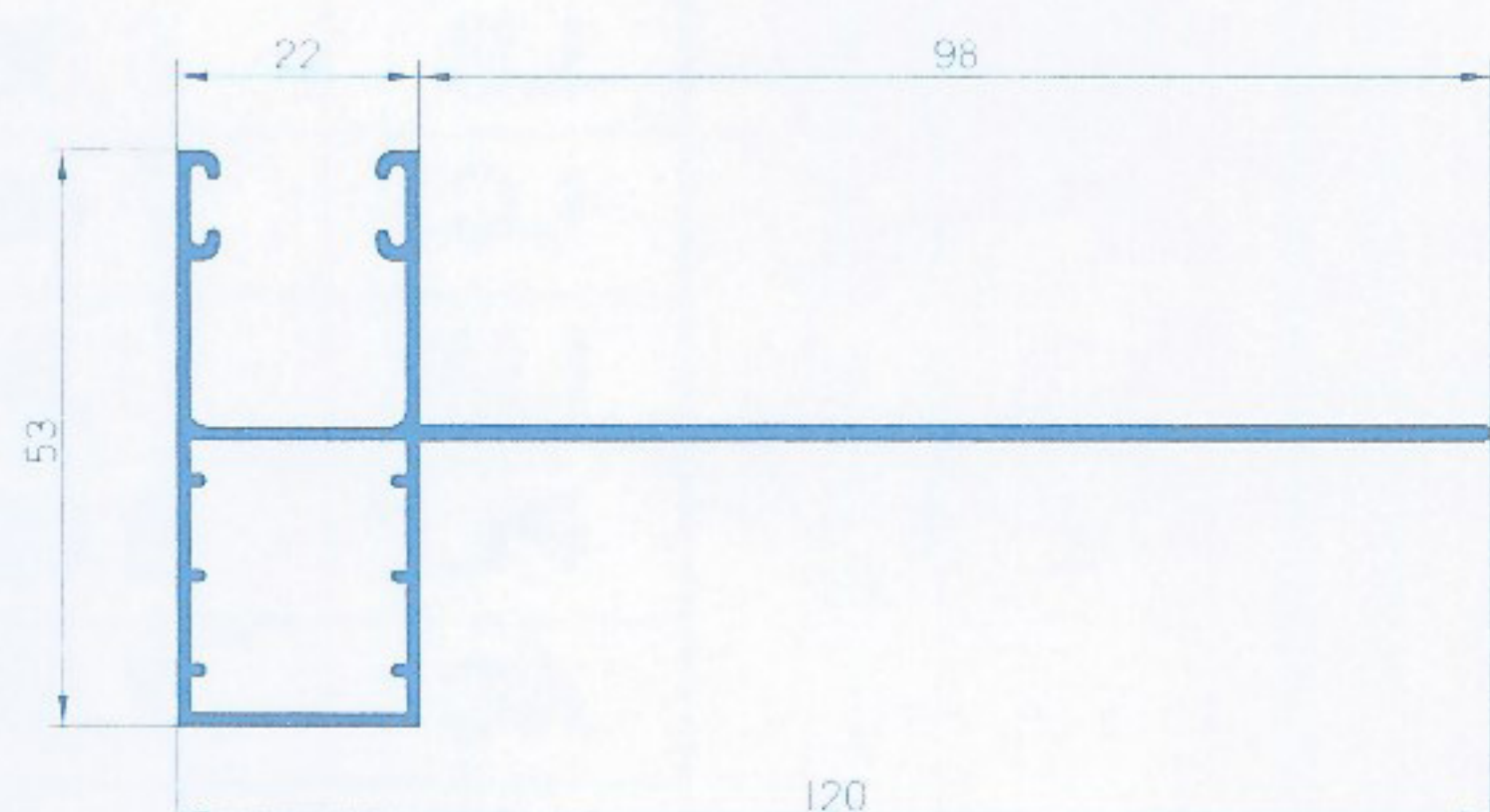

MAINEL MONOBLOCK

Ref.: 2537

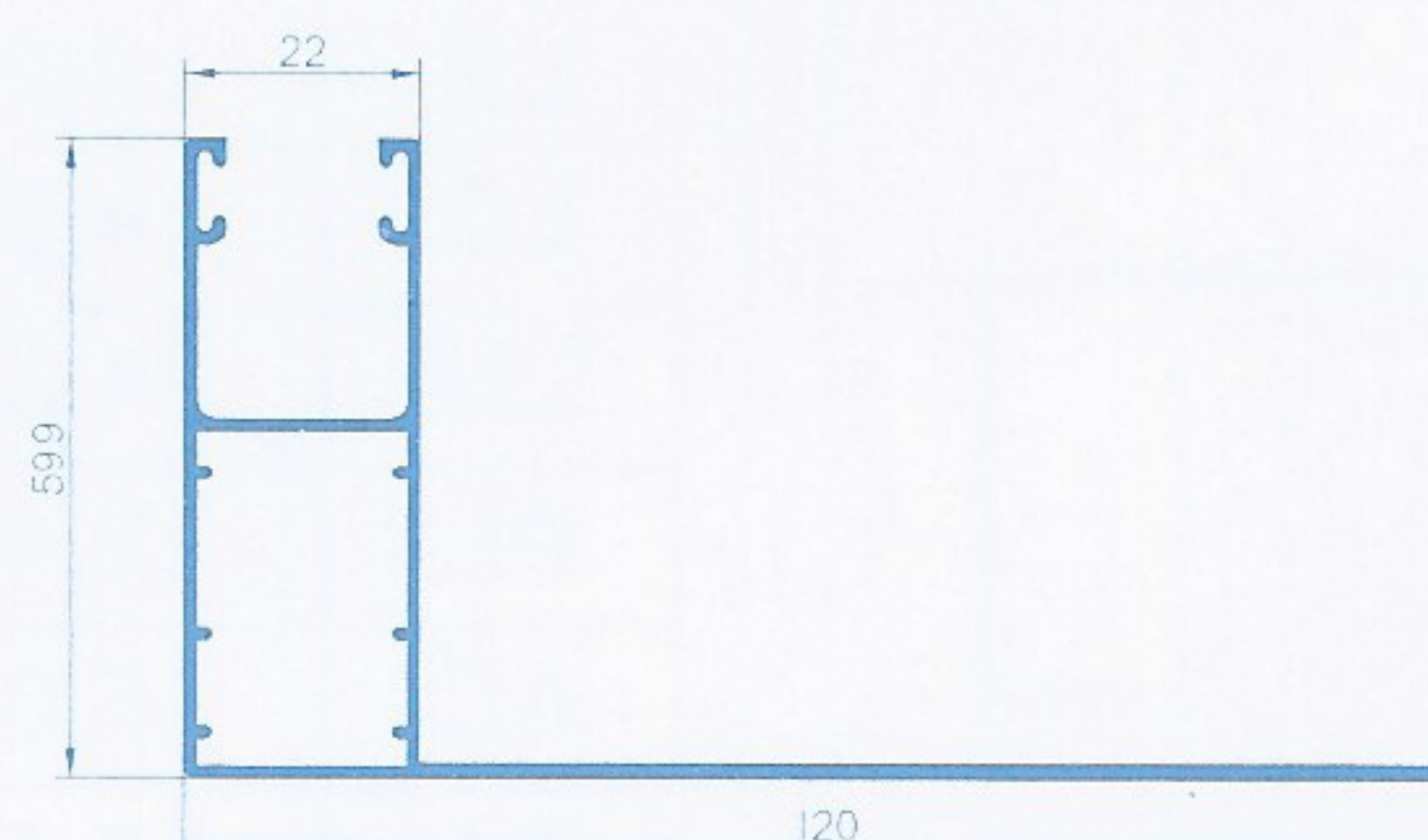

MAINEL MONOBLOCK

Ref.: 2547

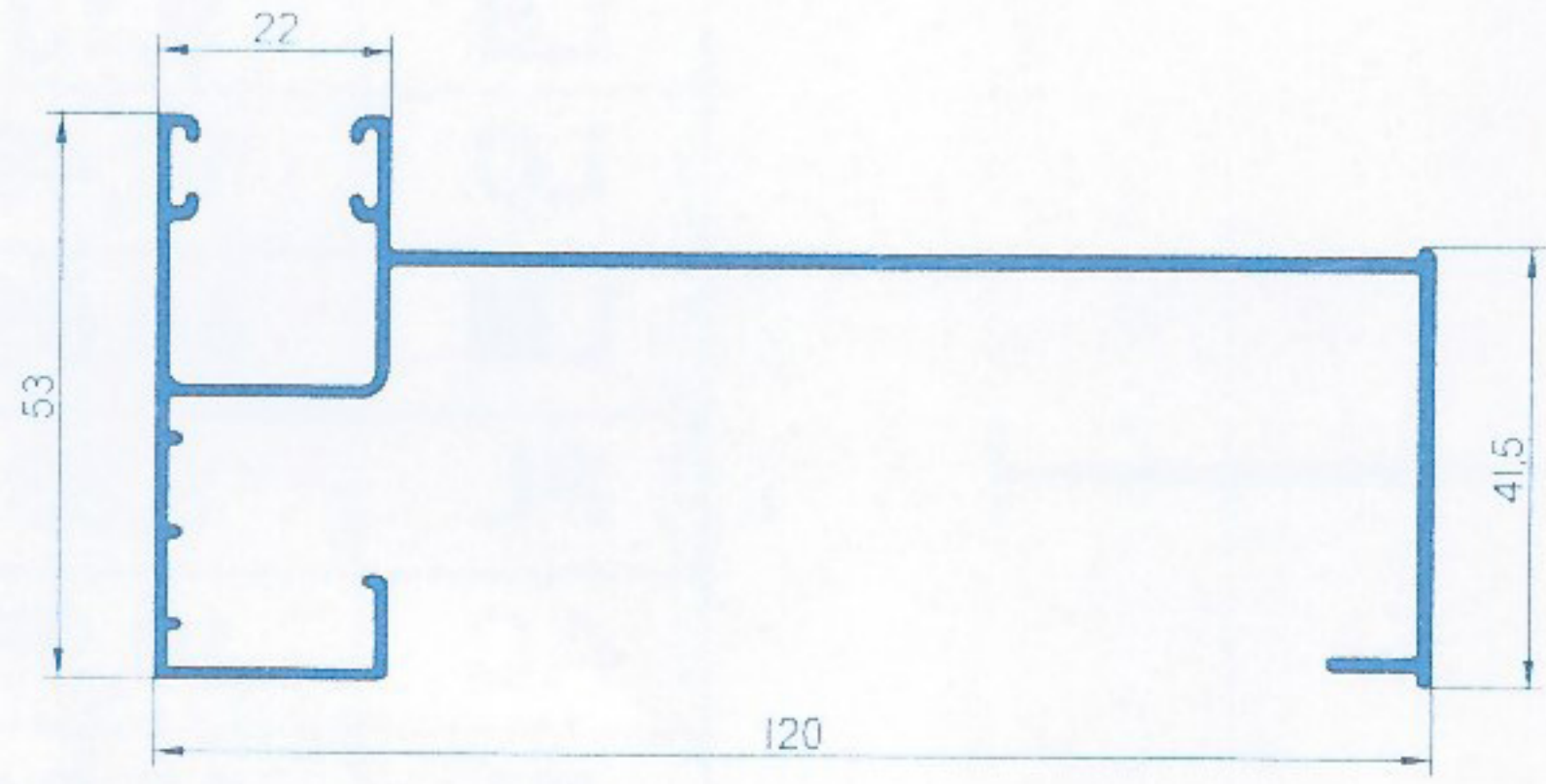

MAINEL MONOBLOCK

Ref.: 2550

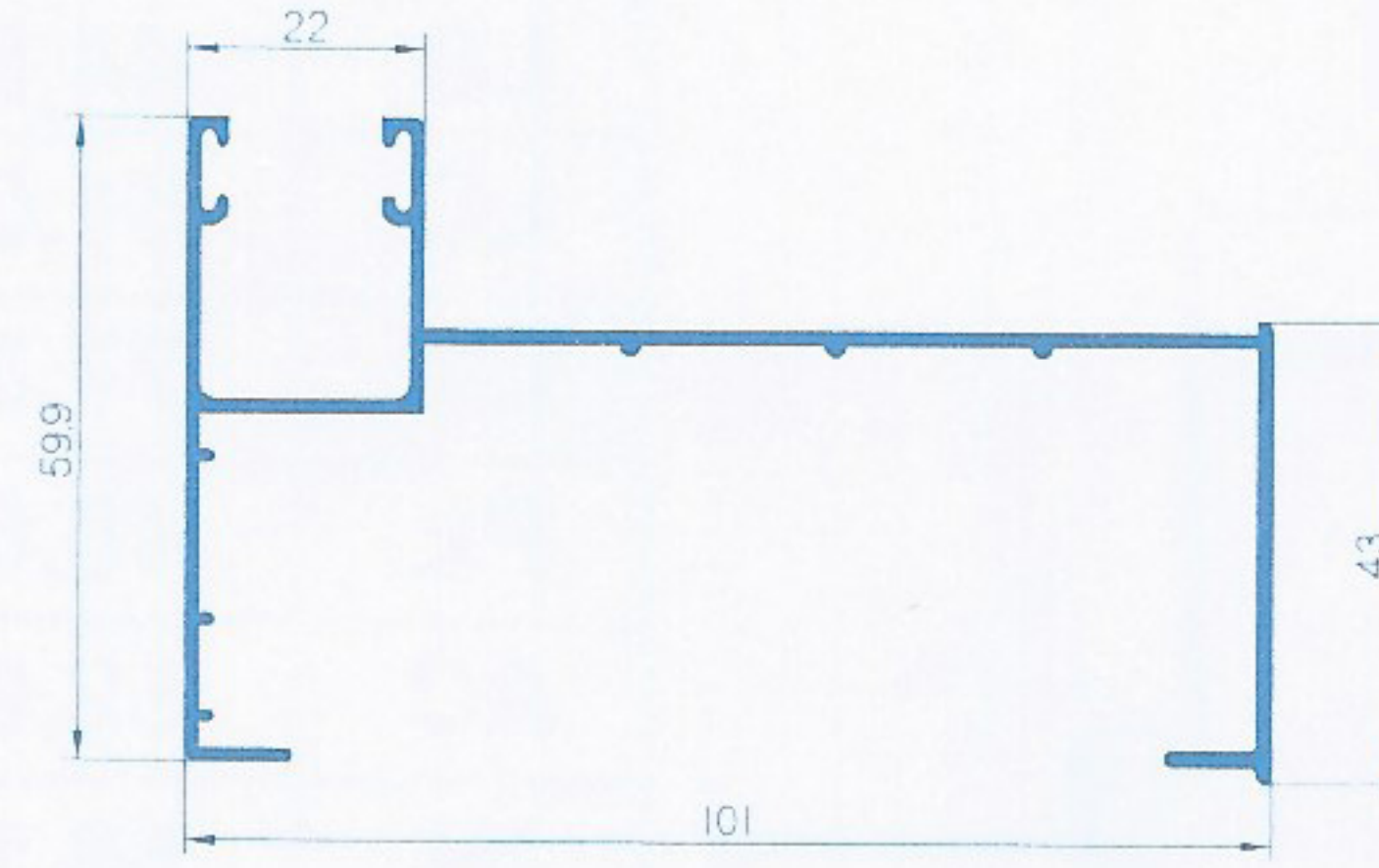

MAINEL 2 PIEZAS

Ref.: 2553

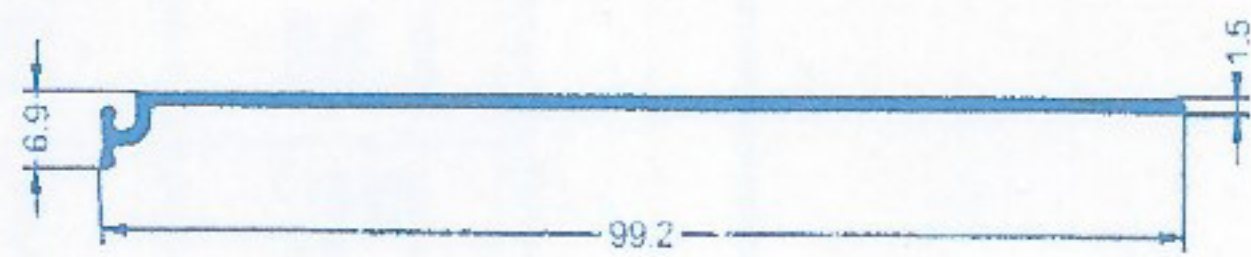

MAINEL MONOBLOCK

Ref.: 2555

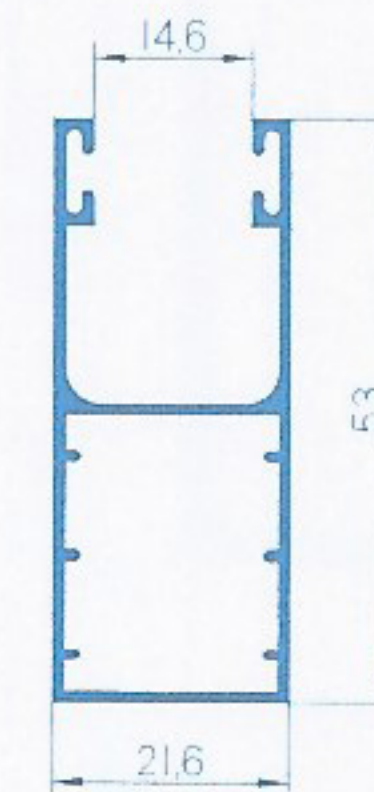

MAINEL MONOBLOCK

Ref.: 2557

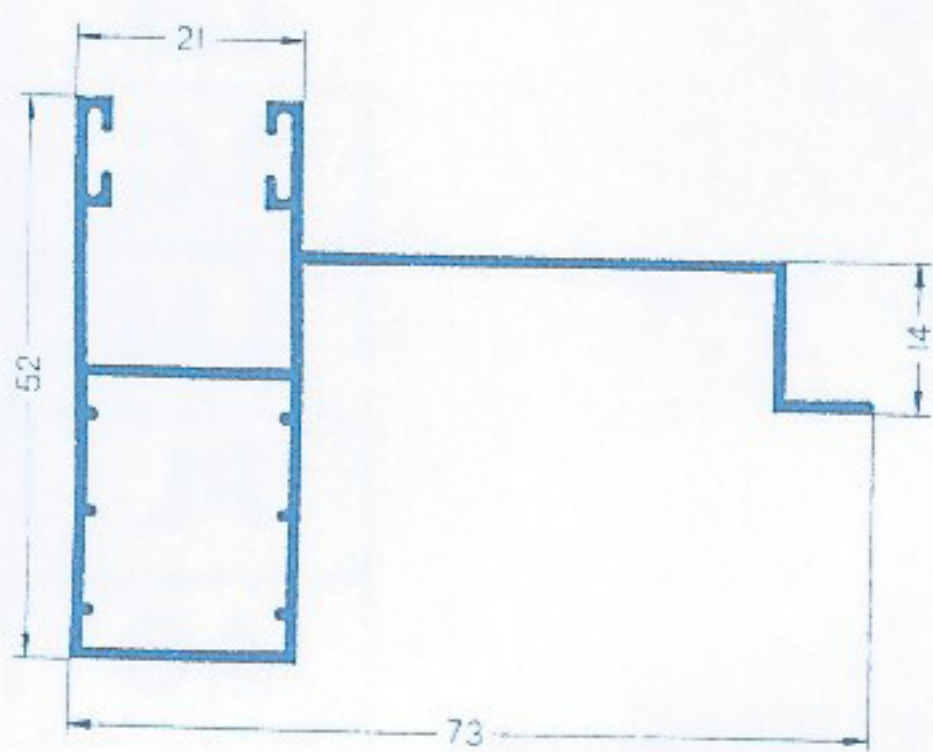

MAINEL MONOBLOCK

Ref.: 2564

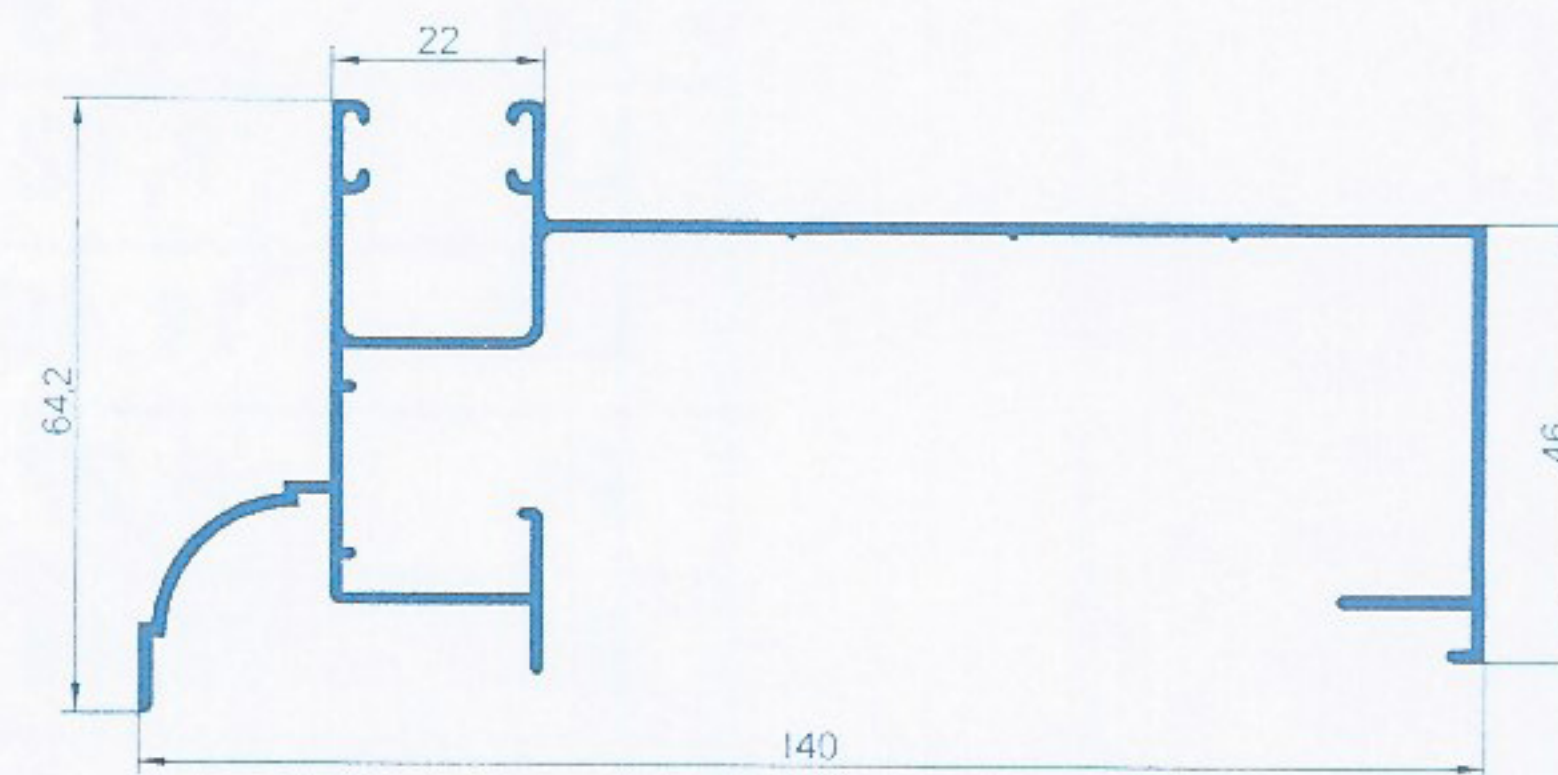

MAINEL MONOBLOCK

Ref.: 2580

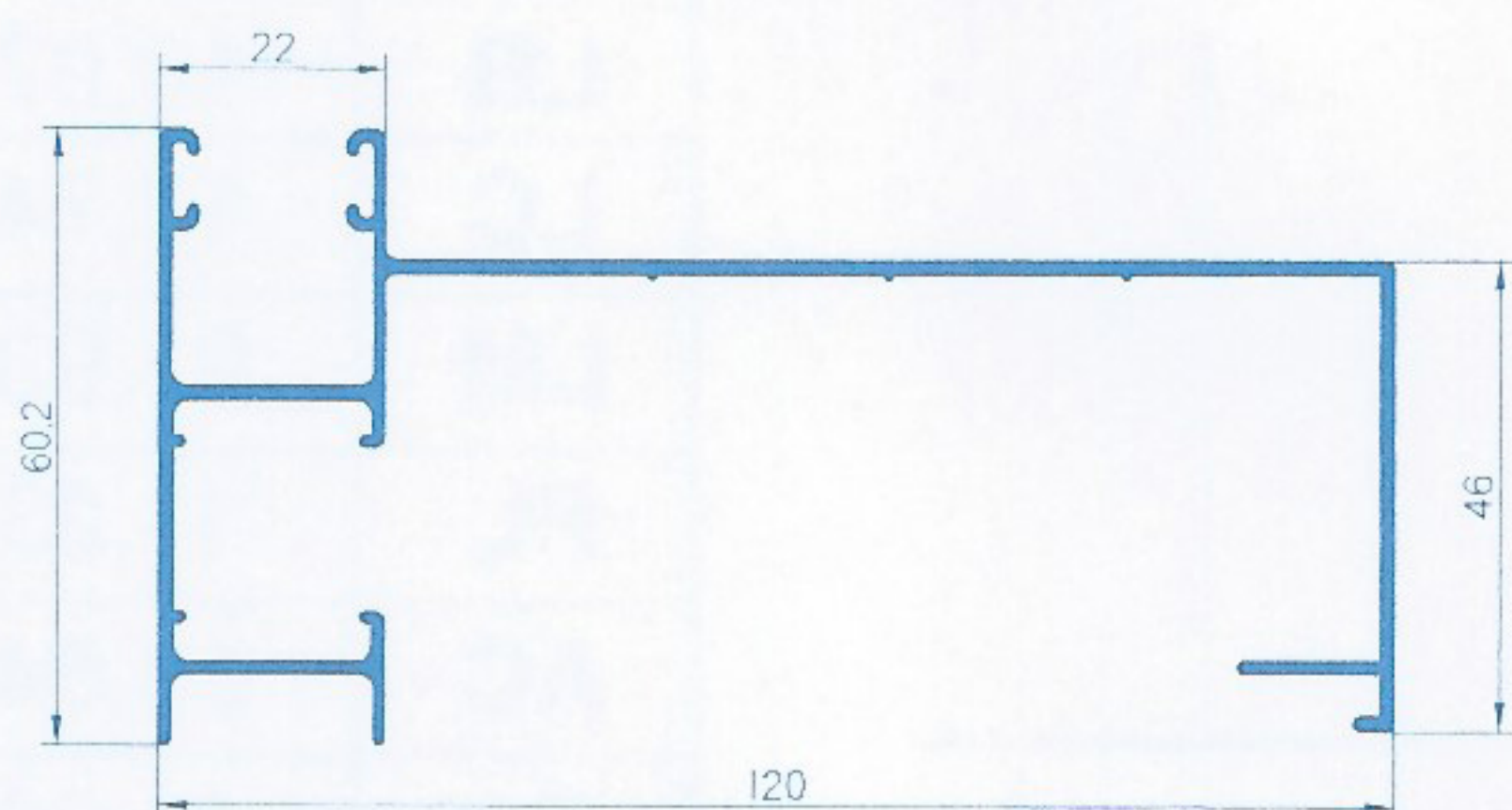

MAINEL 2 PIEZAS

Ref.: 2664

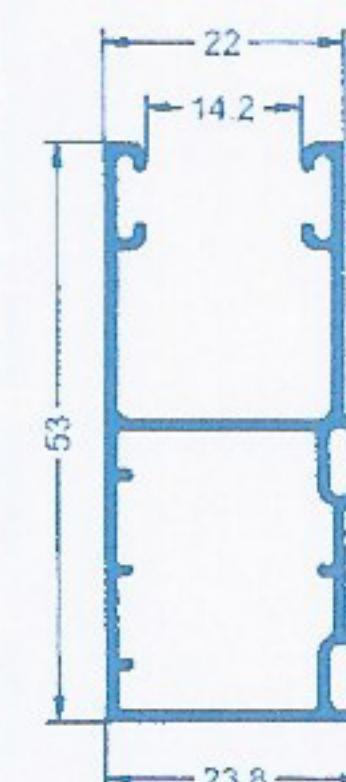

MAINEL MONOBLOCK

Ref.: 4528

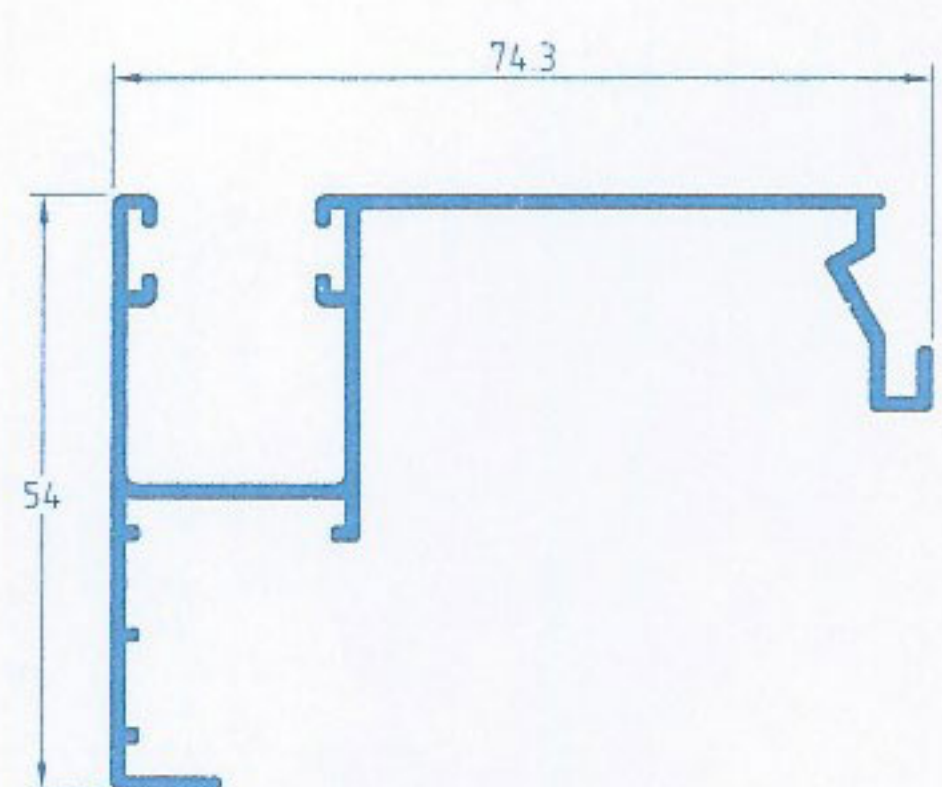

COMPONENTE GUÍA

Ref.: 4955

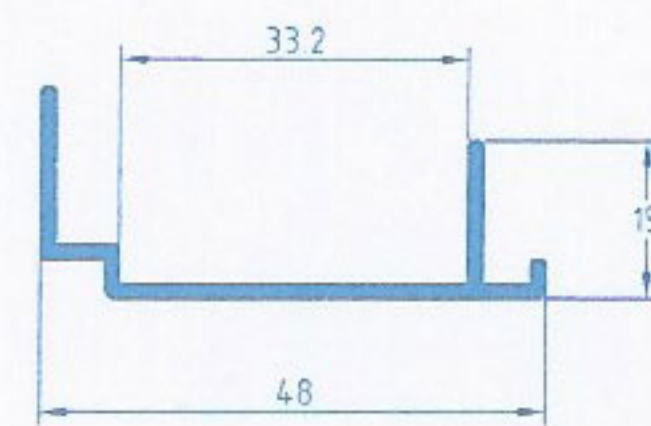

GUÍA CON PREMARCO 130 mm.

Ref.: 5329

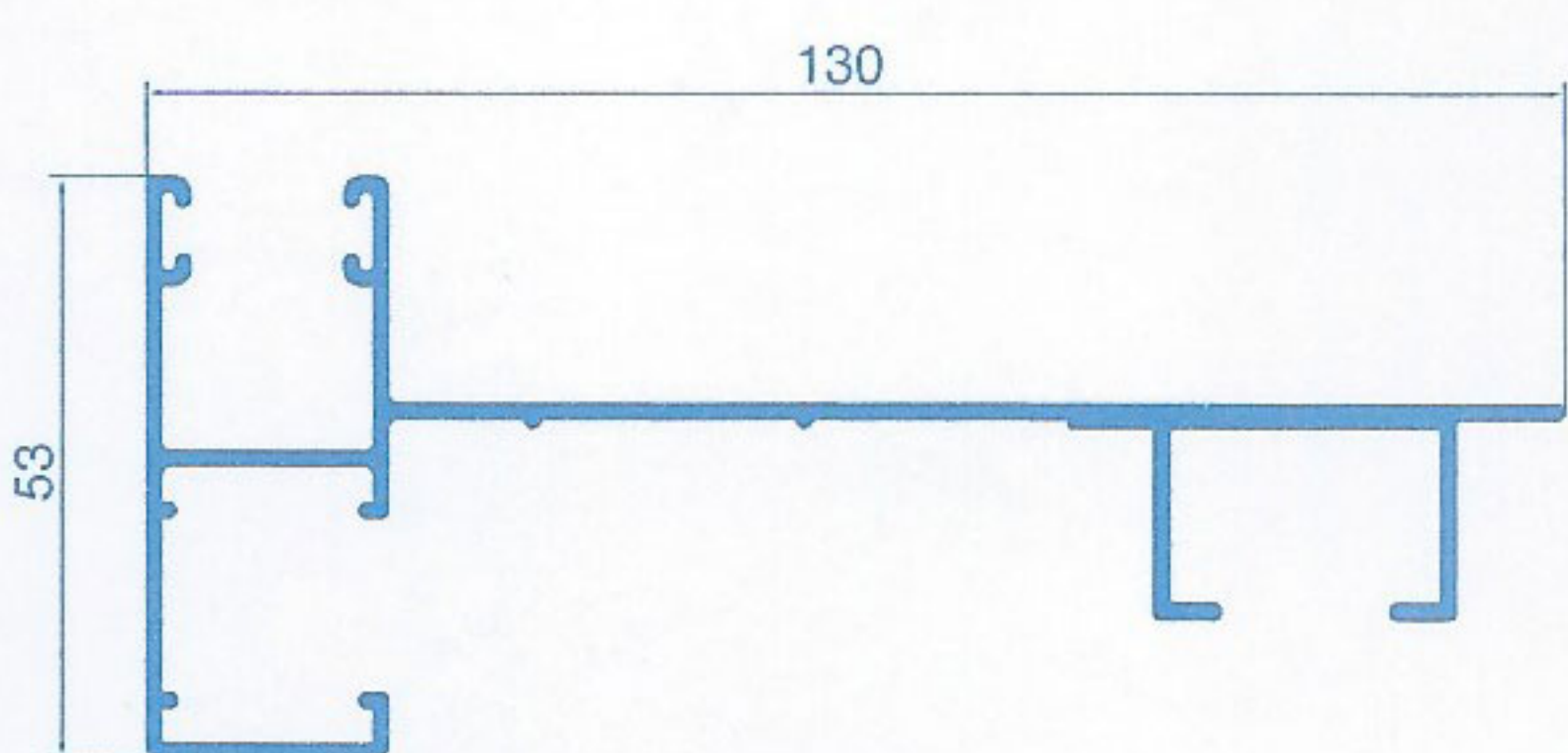

ESQUINERO REGULABLE MONOBLOCK

Ref.: 9622

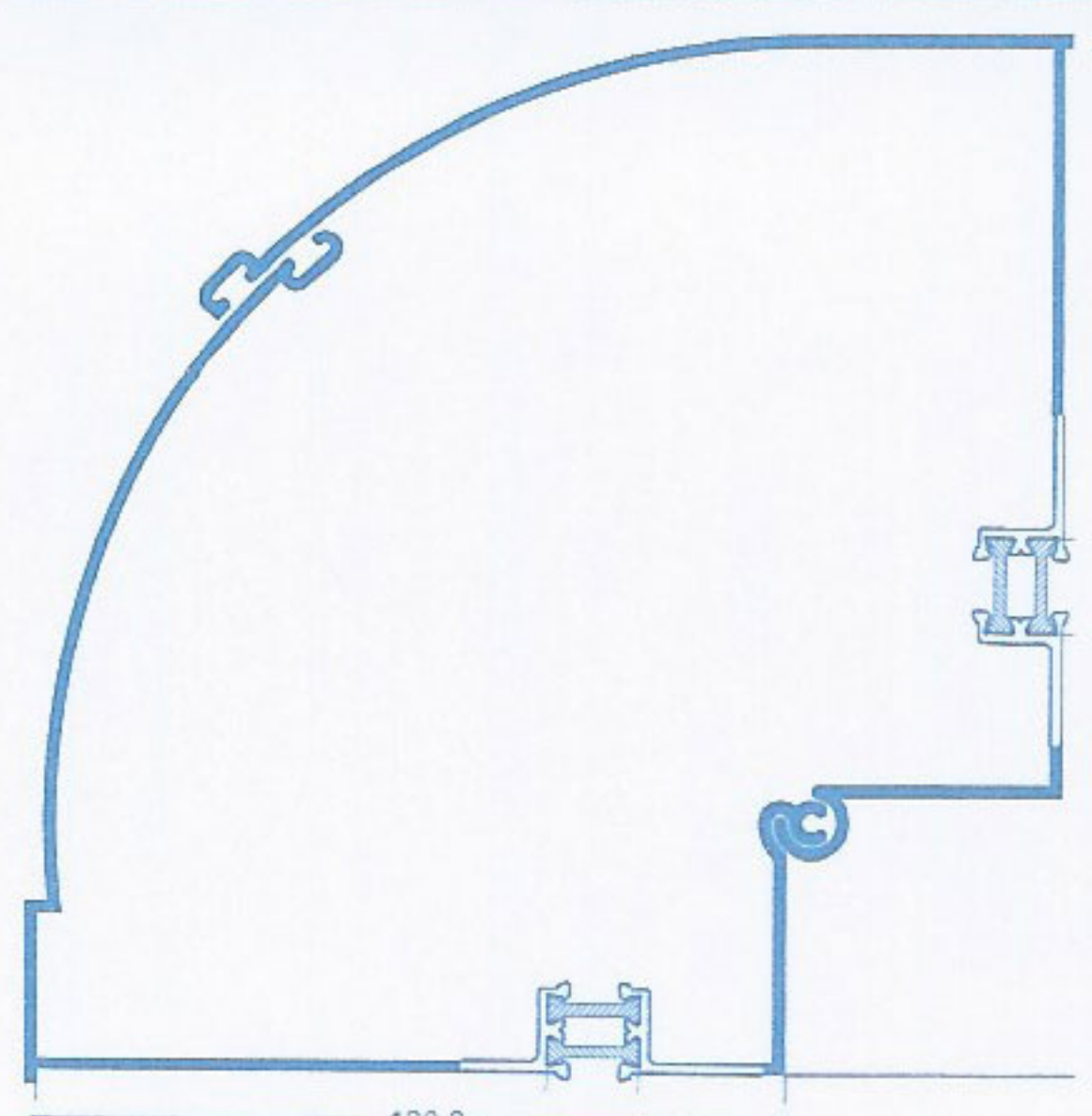

GUÍA ROTURA 100 mm.

Ref.: 9639

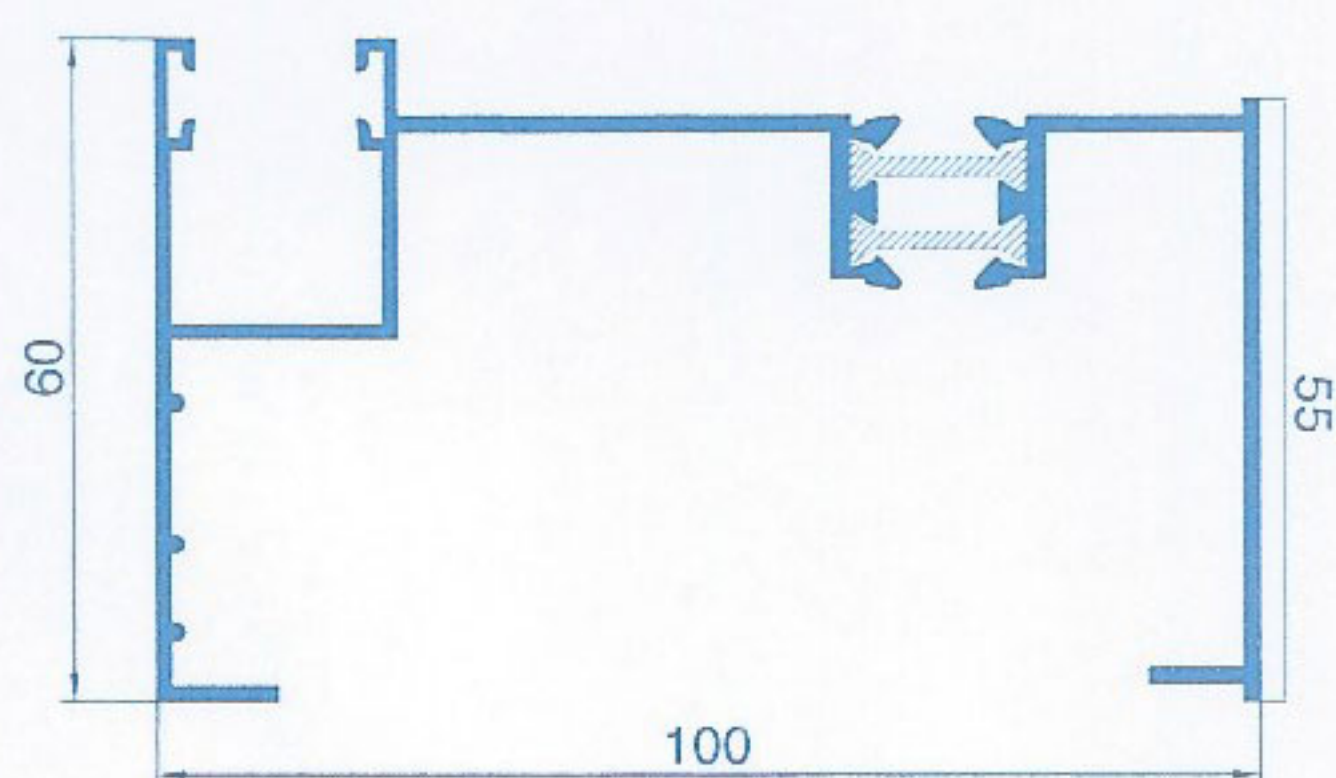

MAINEL MONOBLOCK

Ref.: PT-68

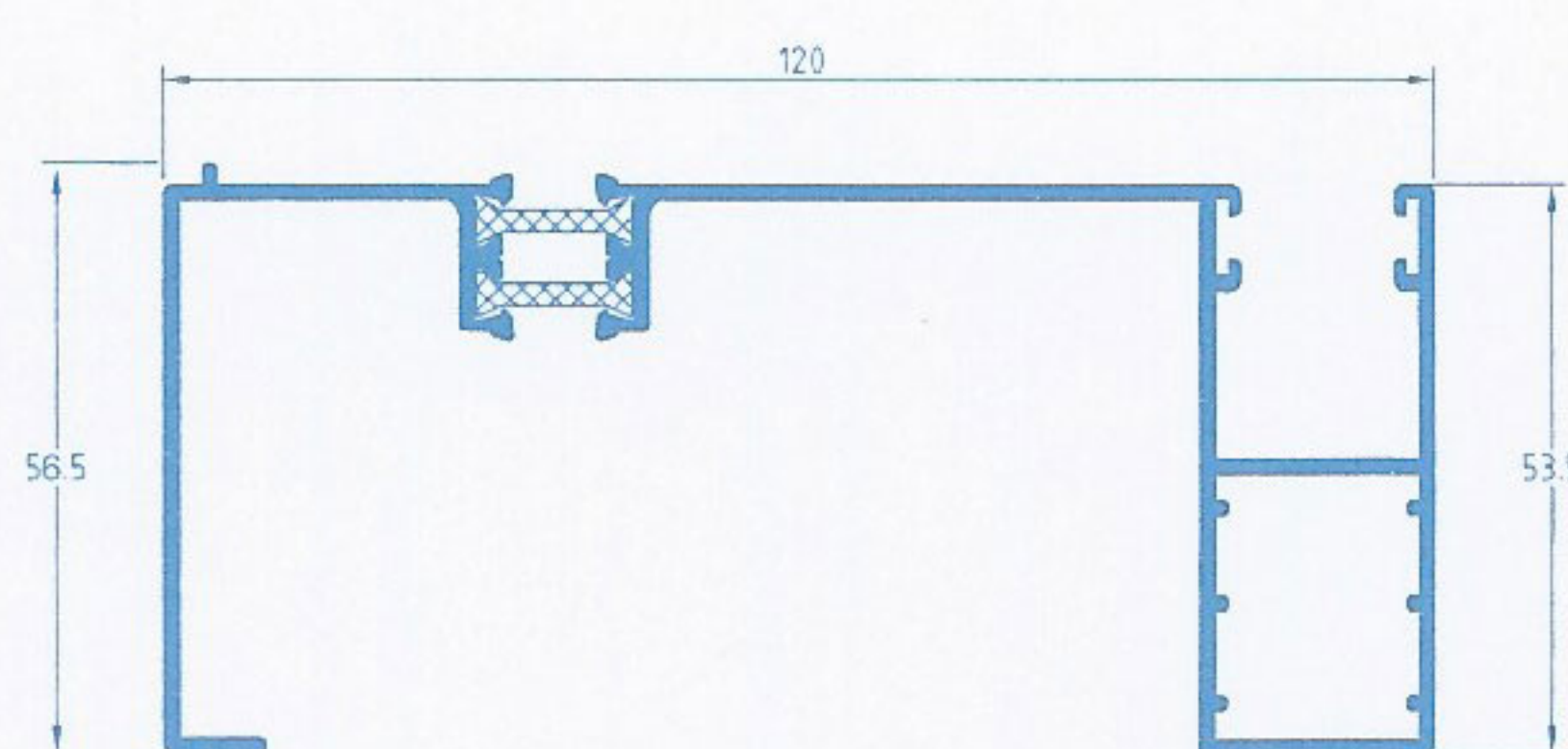

GUÍA CON ROTURA DE 120 mm. PARA SOLAPAR CON VUELTA Ref.: PT-128

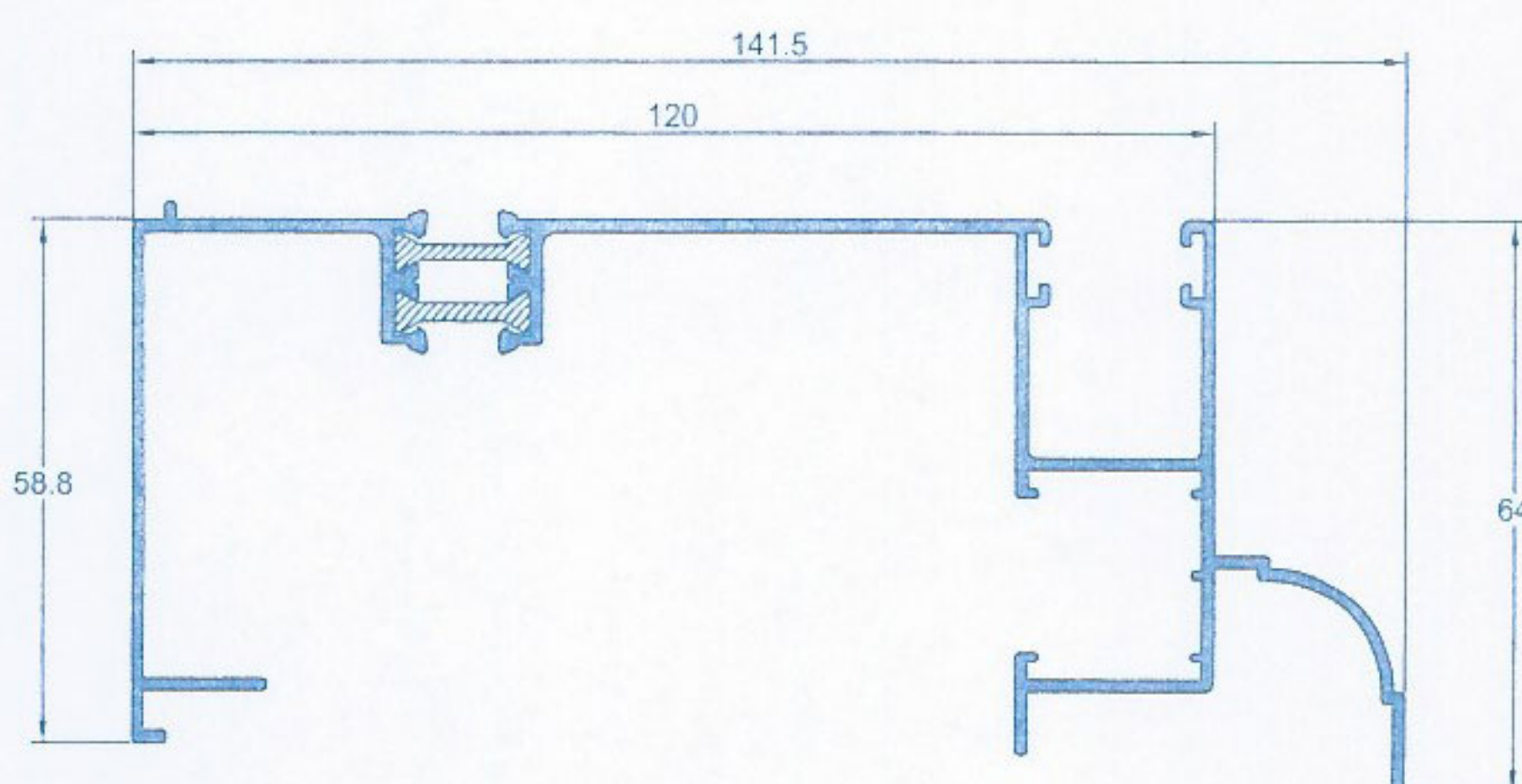

GUÍA CON ROTURA DE 120 mm. PARA SOLAPAR Ref.: PT-168

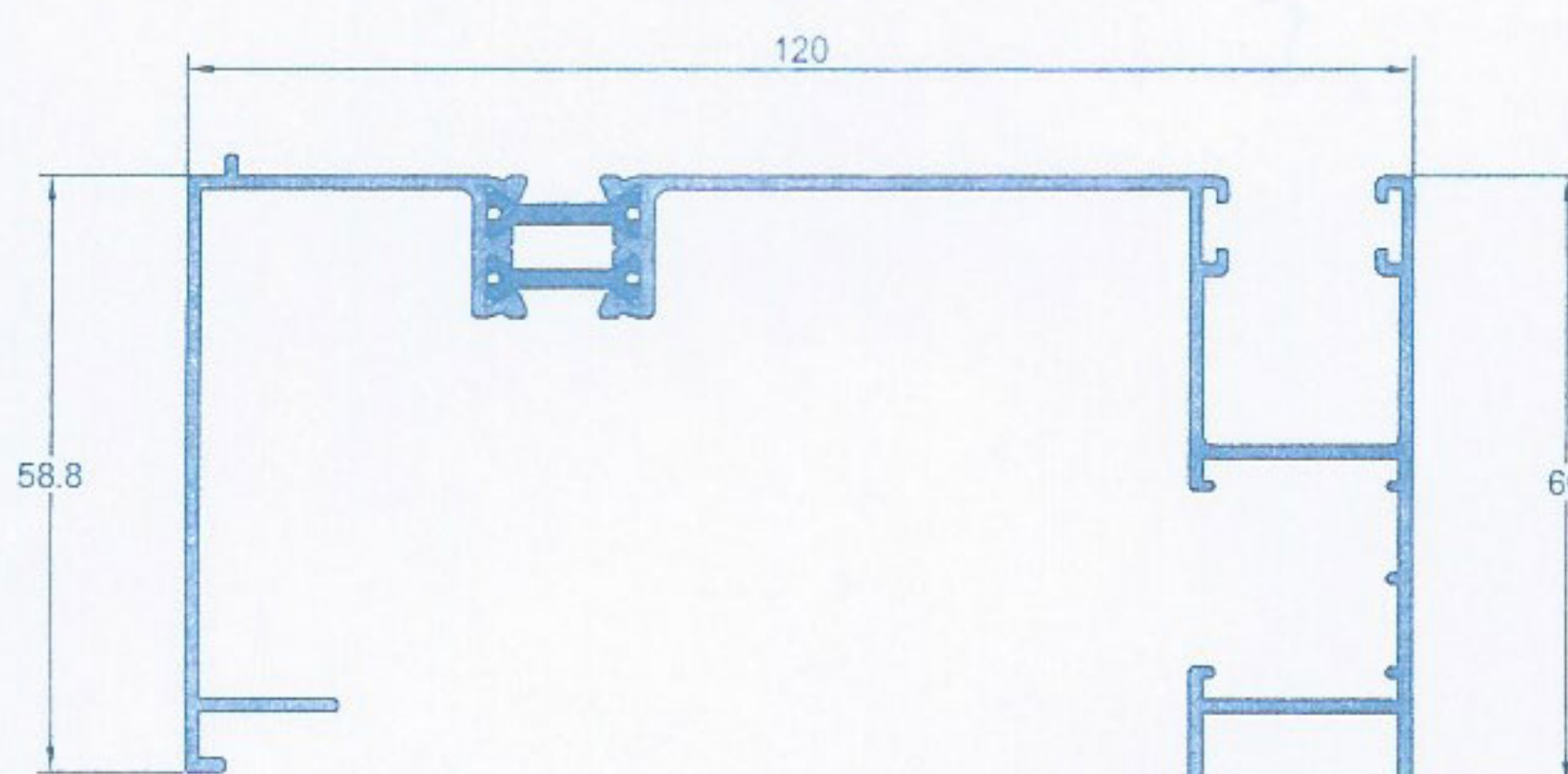

GUÍA CON ROTURA DE 150 mm.

Ref.: PT-172

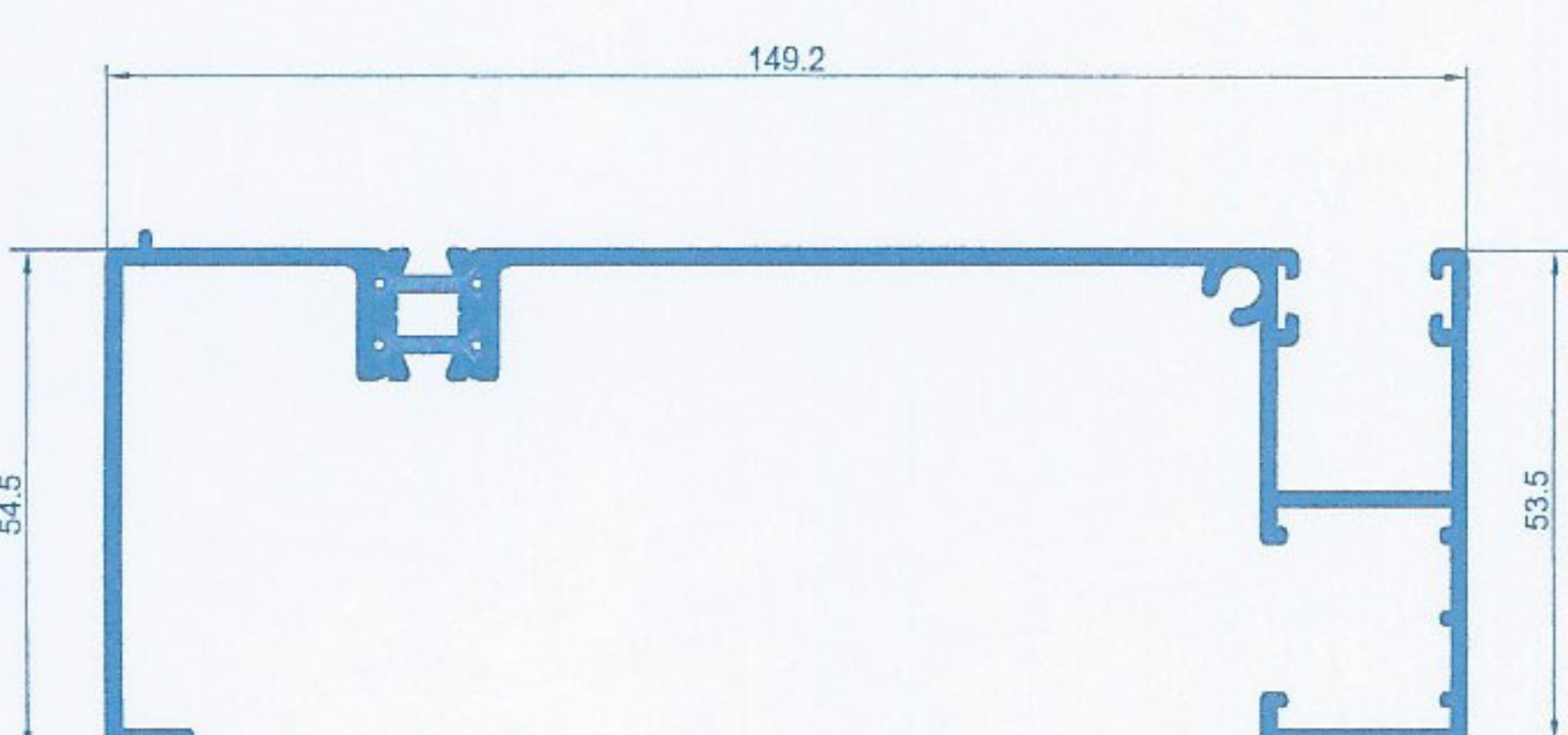

GUÍA ROTURA PARA SOLAPAR 145 mm.

Ref.: PT-197

